



Crompton Instruments Integra and Paladin Transducers

Integra and Paladin Transducers

An extensive range of transducers providing measurement, isolation and conversion of electrical parameters into industry standard DC output signals. The range offers protection against high voltage and overload, and resistance to vibration in harsh electrical environments.

The transducer range also offers multiple analogue outputs in a single housing and individual measurement of most electrical parameters.



Contents

Page

Integra 1560 and 1580 Digital Transducer Systems

2 – 6

Paladin Transducers AT Series Class 0.5

7 – 11

Paladin Transducers 250 Series Class 0.2 and 0.5

12 – 24

Paladin Transducers 250 Series Dimensions

25

Paladin Transducers 250 Series Connection Diagrams

26 – 29

Features

- Extensive range
- High accuracy
- True RMS measurement
- THD measurement and power quality data
- Pulsed, analogue and digital outputs

Benefits

- Cost saving remote metering
- DIN-rail or base mounted options
- Efficient monitoring, control and protection of expensive power assets

Applications

- Switchgear
- Distribution systems
- Generator sets
- Control panels
- Energy management
- Building management
- Utility power monitoring
- Process control
- Motor control

Approvals

UL, CSA and BV

Integra Digital Transducer Systems

Integra 1560 and 1580 transducers provide high accuracy <0.2% measurements and communicate up to 50 major electrical and power quality parameters, including true RMS system values, power quality data and total harmonic distortion (THD) measurement up to the 31st harmonic. The range includes the rail mounted 1560 DIN version and the 1580 variant with a base plate for surface mounting.

Operation

The multi function Integra 1560 and 1580 transducers offer uncomplicated operation and high accuracy <0.2% measurement of single and three-phase voltage, current, frequency, Watts, VAR, VA, energy and power factor, and total harmonic distortion measurement of both phase and system current and voltage. A simple Windows based software package is provided to configure the transducer. Once configured, up to 50 electrical and power quality variables can be simultaneously input into building management systems via pulsed, analogue and digital communication options. Status may also be monitored via a PC through a software package.

Alternatively, an optional menu driven display unit can be used to configure and monitor up to 32 measured parameters. Display panel unit can be permanently mounted next to the transducer or simply connected at times when configuration, adjustment and/or status information is required.

Accuracy

Integra transducers utilise true RMS measurement techniques up to the 31st harmonic, providing <0.2% accuracy. An exceptional tolerance to high harmonic frequencies is achieved from the robust frequency detection method, which is able to lock the fundamental frequency onto any phase. High integrity measurements are possible where the system approximates CT current in the absence of voltage signals.

System Input

Designed for all low, medium and high voltage switchgear and distribution systems, the transducers offer programmable VT and CT ratio capability. Direct connection up to 480V AC with 5A CT inputs is standard, and 1A CT inputs are optional.

System Outputs

Pulsed outputs

Optional pulsed outputs enable retransmission of kWh and kVARh time based parameters. Outputs are pulsed at a rate proportional to the measured kWh active energy, with programmable pulse width and rate. Output relays have fully insulated volt free contacts, with connection via screw clamp terminals.

Analogue outputs

Up to four analogue outputs may be included, enabling transmission of linear parameters. Each analogue channel can be assigned to one of 47 measured parameters with fully adjustable output span and can be configured to operate in normal, reverse, threshold or constant current modes. Analogue outputs share a common return which is galvanically isolated from non-analogue output terminals.

RS485 Digital Communications

RS485 Modbus RTU

Integra 1560 and 1580 transducers have two RS485 communication ports for direct connection to SCADA systems with Modbus RTU protocol, or optionally a single Johnson Controls Metasys NII protocol. The Modbus option includes function 8 subfunction 0, which provides return query data diagnostic support and the ability to change Modbus word order to suit user requirements.

Lonworks Option

The Lonworks option conforms to LonMark Interoperability Guidelines version 3.2. Transducers can be integrated into a single control network without requiring a custom node or network tool development. Lonworks implementations include a Modbus port. This Modbus port is used when a local Integra display is required or for setting up the unit from Crompton Instruments configuration software.



Features

- Measure and communicate up to 50 electrical and power parameters
- High accuracy of <0.2%
- THD measurement and power quality data
- True RMS measurement
- Pulsed, analogue and digital outputs
- Modbus and Lonworks interface options
- Fully programmable VT and CT ratios
- Configurable via software or menu driven interface

Benefits

- Replaces multiple single function transducers
- DIN-rail or base mounted options
- Local or remote configuration and monitoring via building management systems
- ANSI style local or remote LED display option
- Monitoring, control and protection of expensive power assets

Applications

- Switchgear
- Distribution systems
- Control panels
- Energy management
- Building management
- Utility power monitoring
- Process control
- Motor monitoring

Approvals

- UL file no. E200300
- CSA pending

Profibus Option

The Profibus option provides an RS485 interface capable of operating at up to 10Mb/s. Profibus implementations include a Modbus port. This Modbus port is used when a local Integra display is required or for setting up the unit from Crompton configuration software.

Software Configuration

Configuration of up to 50 measured parameters, outputs, pulsed relays, current and power demands are programmed through a Windows style user interface. The transducer is connected to a PC's COM port via an RS485/RS232 converter.

The software allows the user to load and save configuration settings to and from a PC hard disk, and to send and retrieve settings from the transducer. Settings can be saved for later use and can be copied from one Integra transducer to another.

Status information is usually communicated into a building management system, but can also be monitored through configuration software. The software interrogates the selected transducer every few seconds to obtain data, which can be viewed on a dedicated measurements page.

Programmable Display Unit Option

As an alternative to the standard software configuration package, voltage and current transformer ratios, communication options and power measurement parameters can be configured via the optional menu driven Integra DIS-1540 display unit.

A simple two button interface on the front panel of the unit allows display of 32 major electrical and power quality parameters. All set-up screens are password protected.

Once configured, the status of each parameter can be viewed by scrolling through 13 screens, featuring a 3 line, 4 digit LED display. The unit requires an independent auxiliary power supply and thus may be positioned either locally, or remotely from the transducer at a distance limited only by the communication restrictions of RS485.

Programmable Parameters

Integra 1560 and 1580 transducers are programmed via the RS485 communications port using the configuration software for a Windows based PC, or by using the optional programmable Integra DIS-1540 display unit.

Parameter	Range
Password:	4 digit, 0000 - 9999
Primary current:	max 9999A (360MW max**)
VT primary:	400kV (360MW max**)
Secondary voltage:	nominal system voltage
	** maximum VT and CT ratios are limited so the combination of primary voltage and current does not exceed 360MW at 120% of relevant input
Demand integration time:	8, 15, 20, 30 minutes
Reset:	max demand and active energy registers
Pulse output duration:	60, 100, 200 ms
Pulse rate divisors:	1, 10, 100, 1000
RS485 interface baud rate:	2.4, 4.8, 9.6, 19.2kB
RS485 parity:	odd/even/no, 1 or 2 stop bits
Modbus address:	1 - 247
Analogue outputs:	user definable parameters and ranges

Measurement and communication

Up to 50 electrical and power quality parameters can be measured.

- Volts L1-N, L2-N, L3-N
- Volts L1-L2, L2-L3, L3-L1
- System volts L-N (average)
- System volts L-L (average)
- Current line 1, 2 and 3
- System current (average)
- Current sum
- Current demand
- Current maximum demand
- Neutral current
- System frequency
- Watts 1, 2 and 3
- System Watts (sum)
- Watts demand (import)
- Watts maximum demand (import)
- Watt-hours (import)
- VAr 1, 2 and 3
- System VAr (sum)
- VAr-hours (import)
- VA 1, 2 and 3
- System VA (sum)
- Power factor 1, 2 and 3
- System power factor (average)
- Phase angle 1, 2 and 3
- System phase angle (average)
- THD volts 1, 2 and 3
- THD system volts (mean)
- THD amps 1, 2 and 3
- THD system amps (mean)

Measurement and display

Up to 32 electrical and power quality measurements can be configured and monitored on the DIS-1540 optional display unit. These parameters appear in the following order.

- 1 System volts
System current
System kW
- 2 System volts THD %
System current THD %
- 3 Volts L1 - N (4-wire only)
Volts L2 - N (4-wire only)
Volts L3 - N (4-wire only)
- 4 Volts L1 - L2
Volts L2 - L3
Volts L3 - L1
- 5 Volts Line 1 THD %
Volts Line 2 THD %
Volts Line 3 THD %
- 6 Current L1
Current L2
Current L3
- 7 Current Line 1 THD %
Current Line 2 THD %
Current Line 3 THD %
- 8 Neutral current (4-wire only)
Frequency
Power factor
- 9 kVAr
kVA
kW
- 10 kW Hr (7 digit resolution)
- 11 kVAr Hr (7 digit resolution)
- 12 kW demand
Current demand
- 13 kW maximum demand
Current maximum demand

Specifications

Input	
Nominal input voltage:	57.7 – 277V L-N, 100 – 480V L-L
Max continuous input voltage:	120% of nominal
Max short duration input voltage:	2 x for 1 second, repeated 10 times at 10 second intervals
System VT ratios (primary):	any value up to 400kV **
Nominal input voltage burden:	< 0.2 VA
Nominal input current:	5A (1A option)
System CT primary values:	9999 max 360MW **
Max continuous input current:	120% nominal
Max short duration current input:	20 x for 1 second, repeated 5 times at 5 second intervals
Nominal input current burden:	< 0.6 VA
	** maximum VT and CT ratios are limited so the combination of primary voltage and current does not exceed 360MW at 120% of relevant input
Outputs	
RS485 communications:	two-wire half duplex
Baud rates:	2400, 4800, 9600, 19200
Pulsed:	clean contact SPNO, 100V DC 0.5A max
Pulse duration:	60, 100 or 200 milliseconds
Pulsed outputs:	up to 2
Analogue outputs:	up to 4
Auxiliary	
Standard nominal supply voltage:	100 – 250V, AC or DC (85 – 287V, AC absolute) (85 – 312V, DC absolute)
AC supply frequency range:	45 – 66Hz
AC supply burden:	6 VA
Optional auxiliary DC supply:	12 – 48V, DC (10.2 – 60V, DC absolute)
DC supply burden:	6 VA
Measuring ranges	
Voltage:	80 – 120% of nominal (functional 5 – 120%)
Current:	5 – 120% of nominal (functional 5 – 120%)
Frequency:	45 – 66Hz
Power factor:	0.8 capacitive – 1 – 0.8 inductive
THD:	Up to 31st harmonic 0% – 40%
Energy:	7 digit resolution
Reference conditions	
Ambient temperature:	23°±1°C
Input frequency:	50 or 60Hz ±2%
Input waveform:	sinusoidal (distortion factor < 0.005)
Auxiliary supply voltage:	nominal ±1%
Auxiliary supply frequency:	nominal ±1%
AC auxiliary supply waveform:	sinusoidal (distortion factor < 0.05)
Magnetic field of origin:	terrestrial flux
Accuracy	
Voltage:	±0.17% of range
Current:	±0.17% of range
Frequency:	0.15% of mid frequency
Power:	±0.2% of range
Power factor:	1% of unity
Reactive power (VAr):	±0.5% of range
Apparent power (VA):	±0.2% of range
THD:	±1%
Neutral current:	±0.95% of range
Energy:	KWh 1% IEC1036
KVArh:	2%
Temperature coefficient:	voltage and current typical: 0.013%/°C Watts typical: 0.018%/°C
Update time:	1 second for display, 250 ms for optional digital port
Analogue output:	±0.2%

Specifications continued

Enclosure	
Enclosure style:	DIN-rail or base mounted
Compliant with:	UL E200300 and IEC 1010/BSEN 61010-1
Material:	Polycarbonate with additional metal base plate on the 1580 for surface mounting
Terminals:	Shrouded screw clamp with additional metal base plate on the 1580 for surface mounting
Dielectric voltage:	Tested at 3.25kV RMS 50Hz for 1 minute between all electrical circuits
Operating temperature:	-20 to +60°C
Storage temperature:	-30 to +80°C
Relative humidity:	0 - 90% non condensing
Warm-up time:	1 minute
Shock:	30g in 3 planes
Vibration:	10 - 55Hz, 0.15mm amplitude
DIN-rail transducer dimensions:	5.5" high* x 3.72" wide x 3.72" deep 139.6mm high x 94.4mm wide x 94.4mm deep *Excluding connectors
Base mounted transducer dimensions:	5.2" high* x 3.74" wide x 5.24" deep 131.5mm high x 95mm wide x 133.5mm deep *Excluding connectors
Transducer display dimensions:	4.31" high x 4.31" wide x 2.9" deep 109.4mm high x 109.4mm wide x 73.7mm deep
Panel cut out (display):	4.06" (103mm) diameter, 4 stud positions

Accuracy Definition

Error changes due to quantity variations as described in IEC688:1992 section 6.
THD accuracy based on a typical harmonic profile.

Ordering Codes

Description	Cat. no.
INT-1561-* ⁻⁵ -** ^{-option} -***	Integra 1560 1-phase 5A CT input, DIN-rail
INT-1562-* ⁻⁵ -** ^{-option} -***	Integra 1560 1-phase 3-wire 5A CT input, DIN-rail
INT-1563-* ⁻⁵ -** ^{-option} -***	Integra 1560 3-phase 3-wire 5A CT input, DIN-rail
INT-1564-* ⁻⁵ -** ^{-option} -***	Integra 1560 3-phase 4-wire 5A CT input, DIN-rail
INT-1581-* ⁻⁵ -** ^{-option} -***	Integra 1580 1-phase 5A CT input, base mount
INT-1582-* ⁻⁵ -** ^{-option} -***	Integra 1580 1-phase 3-wire 5A CT input, base mount
INT-1583-* ⁻⁵ -** ^{-option} -***	Integra 1580 3-phase 3-wire 5A CT input, base mount
INT-1584-* ⁻⁵ -** ^{-option} -***	Integra 1580 3-phase 4-wire 5A CT input, base mount
*Input voltage suffix	
L	57.7-139V L-N 114-278V L-L (57.7-139V L-N) 100-240V L-L (57.7-139V L-N)
M	140-277V L-N 279-480V L-L (140-240V L-N) 241-480V L-L (140-277V L-N)
**Auxiliary supply suffix	
L	12-48V DC
M	100-250V AC/DC
*** Communications suffix	



Sample order code

INT-1564-M-5-M-120
Integra 1560 transducer, 3-phase 4-wire, DIN-rail mounted, 241 to 480V L-L nominal input voltage, 5 A CT input, auxiliary supply 100 - 250V AC or DC, one relay pulsed output and two RS485 Modbus communication ports.

Additional code for analogue outputs

=1 0-20 mA, 10V compliance (user configurable as 4-20 mA)
=3 -1/0/+1 mA, 10V compliance

	Pulsed/relay outputs	RS485 Modbus	RS485 interface Modbus or Johnson Controls Metasys NII	Profibus	Lonworks	Analogue outputs
010		1				
011		1				1
012		1				2
013		1				3
014		1				4
020		1	1			
021		1	1			1
022		1	1			2
023		1	1			3
024		1	1			4
040		1			1	
060		1		1		
110	1	1				
111	1	1				1
112	1	1				2
113	1	1				3
114	1	1				4
120	1	1	1			
121	1	1	1			1
122	1	1	1			2
123	1	1	1			3
124	1	1	1			4
210	2	1				
220	2	1	1			

Dimensions

Integra 1560 DIN-rail Mounted Transducer

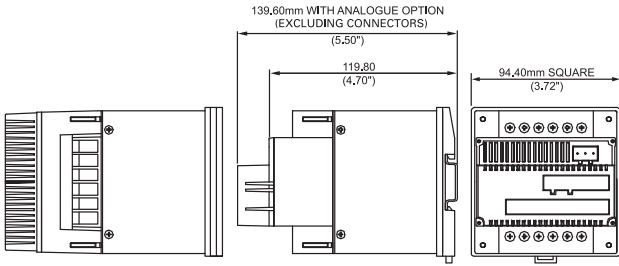

Integra 1580 Base Mounted Transducer

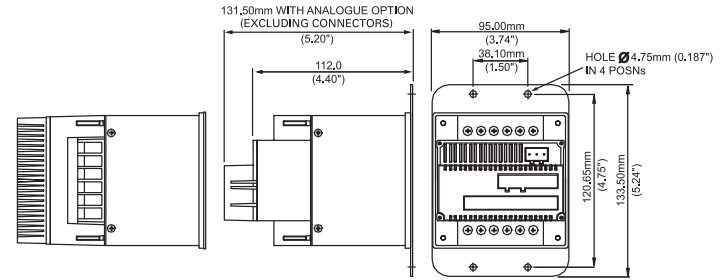

Optional Remote Display (for use with Integra 1560 or 1580 Transducer)

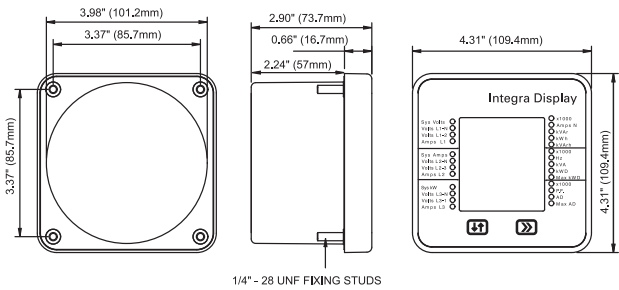

Optional Remote Display Panel Cut-Out

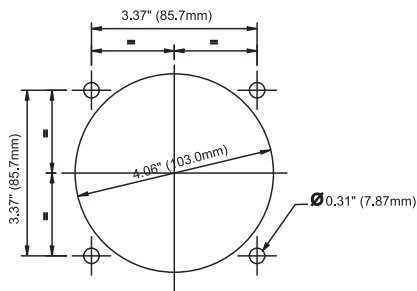

1560/1580 - 3-phase 3-wire Unbalanced Load

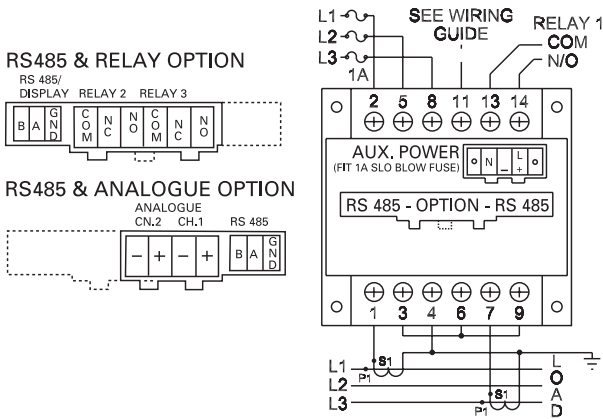

1560/1580 - 3-phase 4-wire Unbalanced Load

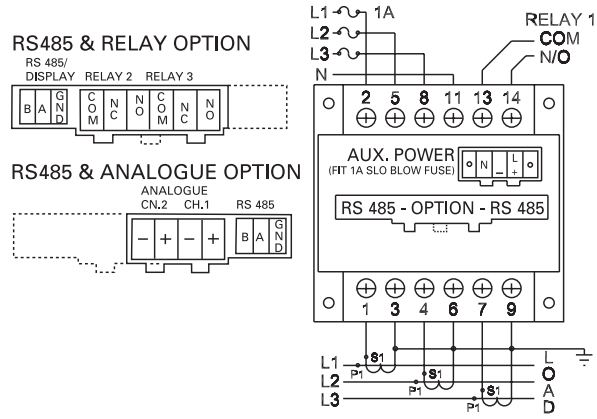

DIS-1540 Remote Display

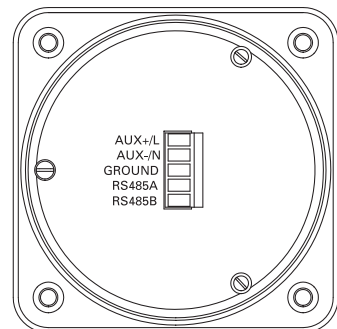

Auxiliary Supply

The Integra family should ideally be powered from a dedicated supply, either 100 - 250V AC or DC (85V - 280 AC absolute or 85 - 312V DC absolute) or 12-48V DC (10.2 - 60V DC absolute). However, all Integra devices may be powered from a signal source, if in the working range of the chosen auxiliary supply.

Fusing

It is recommended that all voltage lines be fitted with 1 amp fuses.

Safety/Ground Connections

For safety reasons, all CT secondary connections should be grounded in accordance with local regulations.

Paladin AT Transducer Series

The new AT series of Paladin transducers provide a cost effective solution for AC current and voltage measurements.

The range provides measurement, isolation and conversion of electrical parameters into industry standard DC output signals. The range offers protection against high voltage and overload, and resistance to vibration in harsh electrical environments. The new range of transducers features user selectable multiple analogue outputs in a single housing and individual measurement of current, voltage and frequency.

The Paladin transducer range is the workhorse of the industry, thoroughly proven and installed in thousands of locations across the world. The new AT range offers the same high quality performance and reliability in a cost effective package.

The product features a DIN-rail mounted enclosure, simple connection and user selectable analogue outputs. The AT series transducers will measure to class 0.5 accuracy.

Overview

Paladin AT transducers can be used for measuring the following parameters:

- True RMS AC current and voltage
- Average sensing AC current and voltage (self powered)

Advantages

- Converts high voltage signals to low voltage DC outputs
- Limits voltage levels to the attached equipment
- Provide a signal that can be transmitted from the measuring location to a remote point

Safety

Paladin AT transducers are designed for use in harsh electrical environments and feature:

- High protection against overload – 20 x rated current for 1 second
- High degree of mechanical shock and vibration resistance
- Protection against current open and short circuit and voltage open circuit
- Inputs, outputs and power supply are galvanically isolated

Ordering Information

When ordering please specify

1. Product catalogue number (AT1, AT2)
2. Current or voltage input
3. Auxiliary power supply AC or DC (AT1 only)

An example of each product code is available on the product description pages of this brochure.



Features

- DIN-rail enclosure
- Measurement of main electrical parameters
- Conversion to standard DC output signals
- User selectable output configuration
- Outputs suitable for indication and PLCs
- High accuracy
- Zero and span adjustments
- Single phase systems
- Flame retardant case
- Screw clamp terminals

Benefits

- Cost effective remote metering
- Reduction of signal levels for ease of metering
- Isolated output for safety
- Short and open circuit protection
- UK manufactured

Applications

- Switchgear
- Motor control centre, generating sets
- Energy management and building management systems

Standards

- IEC 61326
- IEC 61010-1
- IEC 62053-21
- EN60688
- IEC688
- AS1384
- ANSI. C37
- RoHS Compliant

General Specifications

Performance:	
Designed to comply with	BS6253 part 1 EN60688 IEC688 AS1384 ANSI C37
Input:	
Nominal input voltage	Dependant upon device type (nominal 110V-480V AC)
Max. continuous input overload voltage	120% of nominal
Max. short duration input voltage	2 x range maximum for 1 second repeated 5 times
Nominal input voltage burden	<0.2VA
Nominal input current	Dependant upon device type. (Nominal 5 or 1A AC)
Max. continuous input overload current	120% of nominal
Max. short duration input current	20 x range maximum for 1 second
Auxiliary:	
Operating range	110-240V AC/DC +/-10% 12-48V DC +/-10%
Accuracy:	
Accuracy class	0.5%
Accuracy range	20-120%
Response time	< 400msec from 0-99% of rated output < 250msec from 0-90%
Outputs:	
DC outputs (varies by model and selectable by the end user)	0/1mA into 10K Ω 0/5mA into 2K Ω 0/10mA into 1K Ω 0/20mA into 500 Ω 4/20mA into 500 Ω 0/10V into 1K Ω
Maximum output	24V DC when open circuit
Output ripple	<0.5% full rated output
Current output protection	Fully protected against open and short circuited output
Voltage output protection	Fully protected against open circuited output.
Span adjustment	+/- 10%
Zero adjustment	+/- 2%
Enclosure:	
Enclosure style	DIN-rail mount
Dimensions (nominal)	75 x 90 x 60mm (AT1, AT2)
Material	Polycarbonate to UL94V0
Weight	Dependant upon device type (nominal 200-300g)
Terminals	Shrouded screw-clamp 0.05-4mm wire
Environment:	
Operating temperature	0°C to +60°C
Temperature Coefficient	0.03% per °C typical
Storage temperature	-20°C to +70°C
Relative humidity	0-95% non-condensing
Shock	30g in 3 planes
Vibration	10Hz to 50Hz
Dielectric voltage	Withstand test 3.25kV rms 50Hz for 1 minute between aux and measuring inputs

Paladin AT1 Transducer

True RMS Voltage & Current, Auxiliary Powered

A single-phase input transducer offering voltage or current measurement down to 20% of the nominal input. It offers true RMS measurement of the input voltage or current, measurement of non standard and distorted waveforms and calibrated for sine waves with up to 30% of 3rd harmonic distortion.

The transducer is provided with isolation between input, output and auxiliary.

The transducers have a selection of outputs set by the end user.



General Specifications

Input:	110V, 120V, 130V, 150V, 200V, 220V, 230V, 240V, 250V, 380V, 400V, 415V, 440V, & 480V AC 1A & 5A
Output:	0/1mA, 0/5mA, 0/10mA, 0/20mA, 4/20mA & 0/10V. User selectable via dip-switches, default 4/20mA
Frequency:	50/60Hz
Auxiliary:	110-240 AC/DC 12-48V DC

Product Code

Description	Voltage	Part number
True RMS Voltage Transducer		AT1V-***-§
To build a part number: Where -***- = Input Voltage	110V	-110-
	120V	-120-
	130V	-130-
	150V	-150-
	200V	-200-
	220V	-220-
	230V	-230-
	240V	-240-
	250V	-250-
	380V	-380-
	400V	-400-
	415V	-415-
	440V	-440-
	480V	-480-
	12-48V DC	-L
	110-240V AC/DC	-M
Example: True RMS Voltage Transducer with 120V input and 110-240V AC/DC auxiliary		AT1V-120-M

Description	Current	Part number
True RMS Current Transducer		AT1A-***-§
To build a part number: Where -* = Input Current	1A	CT1
	5A	CT5
	12-48V DC	-L
	110-240V AC/DC	-M
Example: True RMS Current Transducer with 5A input and 12-48V DC auxiliary		AT1A-CT5-L

Paladin AT2 Transducer

Average Sensing Voltage & Current, Self Powered

A single-phase input transducer offering voltage and current measurement down to 20% of the nominal input. Average sensing and calibrated to indicate the RMS value of a sine wave with less than 1% distortion.

Internal power is derived from the input signal and will maintain accuracy to 20% of full scale or less. The transducer is provided with isolation between input and output.

The transducers have a selection of outputs set by the end user.



General Specifications

Input:	110V, 120V, 130V, 150V, 200V, 220V, 230V, 240V, 250V, 380V, 400V, 415V, 440V, & 480V AC
	1A & 5A
Output:	0/1mA, 0/5mA, 0/10mA & 0/20mA. User selectable via dip-switches, default 0/20mA
Frequency:	50/60Hz

Product Code

Description	Voltage	Part number
Self Powered Voltage Transducer		AT2V-***
To build a part number: Where -***- = Input Voltage	110V	-110-
	120V	-120-
	130V	-130-
	150V	-150-
	200V	-200-
	220V	-220-
	230V	-230-
	240V	-240-
	250V	-250-
	380V	-380-
	400V	-400-
	415V	-415-
	440V	-440-
	480V	-480-
Example: Self Powered Voltage Transducer with 120V input		AT2V-120

Description	Current	Part number
Self Powered Current Transducer		AT2A-***
To build a part number: Where -* = Input Current	1A	CT1
	5A	CT5
Example: Self Powered Current Transducer with 5A input		AT2A-CT5

Connection Diagrams

True RMS Voltage & Current Transducer

AT1A

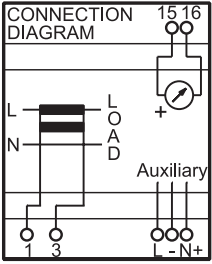

AT1V

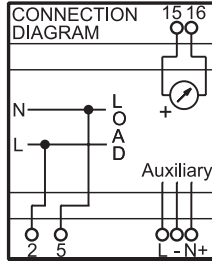

Average Sensing Voltage & Current Transducer

AT2A

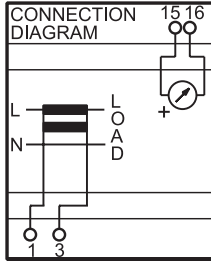

AT2V

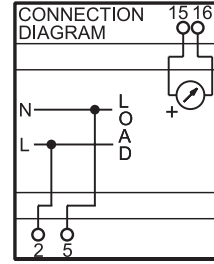

Notes

Auxiliary supply applies only if ordered.

For maximum performance an AC or DC auxiliary is recommended.

Self powering is achievable for a voltage variation of less than 20%.

Analogue Output Dip Switch Selection Guide

True RMS Voltage & Current Transducer

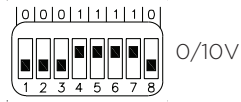
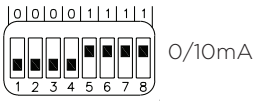
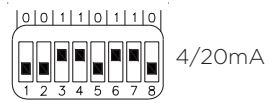
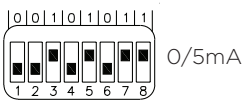
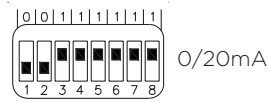
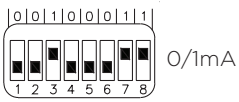

Average Sensing Voltage & Current Transducer

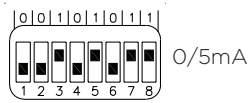
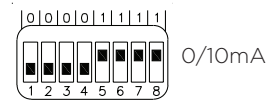
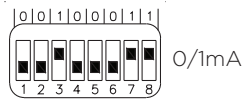

Dimensions

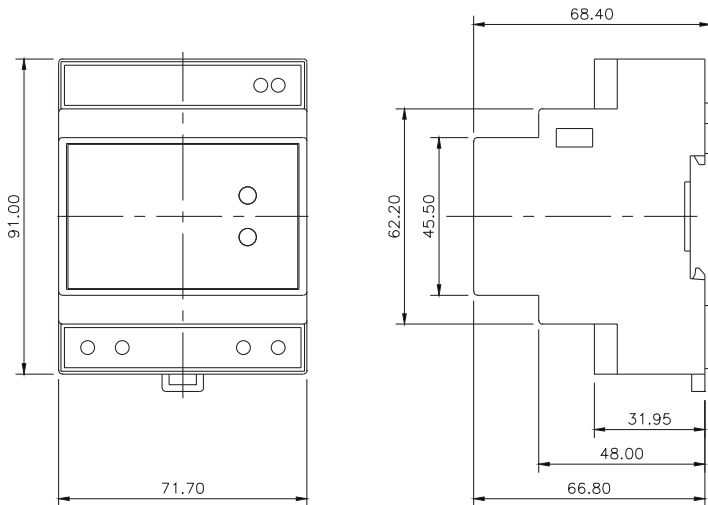

Paladin Transducers

250 Series Class 0.5 and Class 0.2

An extensive range of transducers providing measurement, isolation and conversion of electrical parameters into industry standard DC output signals. The range offers protection against high voltage and overload, and resistance to vibration in harsh electrical environments. The transducer range also offers multiple analogue outputs in a single housing and individual measurement of most electrical parameters.

Advantages

- Convert high voltage signals to a low voltage DC output
- Limit voltage levels to the attached equipment and minimise the possibility of overloads or transients being passed on
- Provide a signal that can be transmitted from the measuring location to a remote point

Safety

Crompton transducers and transmitters are designed for use in harsh electrical environments and feature:

- High protection against overload - 20 x rated current for 1 second
- High degree of mechanical shock and vibration resistance
- Protection against high voltage
- Inputs, outputs and power supply are galvanically isolated (excluding resistance transmitters)

Ordering Information

When ordering please specify:

1. Product catalogue number
2. Current and/or voltage
3. Frequency
4. Auxiliary voltage AC or DC
5. For power products:
 - a. VT & CT ratios
 - b. System configuration i.e. single-phase, three-phase, three or four-wire, balanced or unbalanced load
 - c. required primary power level for DC full output
6. National specification indicated by 7th digit in the product number

253 Paladin Transducers, Class 0.5

The workhorse of the industry, thoroughly proven and installed in thousands of locations across the world. This range offers a very wide range of functions to complement the 256 Paladin range of power transducers. Functions include Voltage, current, frequency, tap position and resistance.

256 Paladin Transducers, Class 0.5

The industry standard power transducer, incredibly popular and available in a huge range of metering options. Power transducers are also available to special order with calibration at non standard frequencies. Alongside the Watt, VAR and VA transducers, the range also includes 3 in one current or voltage transducers and a DC to DC transducer.

252 Paladin Advantage Transducers, Class 0.2

Our premium range of higher specification transducers for voltage current and frequency offering Class 0.2 measurement of up to eight electrical parameters. These products are housed in an industry standard 2" (50mm) wide case. The range offers resistance to EMC protection against high voltage and overload, temperature extremes and resistance to vibration in harsh electrical environments.

256-X Paladin Advantage Transducers, Class 0.2

Complementing the 252 Paladin Advantage range and offering multiple outputs and a wide range of options. The 256-X Paladin Advantage products include Watt, VAR, VA, power factor, phase angle, and 3 in 1 voltage, current, or voltage/current/frequency transducers.

250 Signal Isolator

Offers DC isolation of 0-20mA or 4-20mA signals.



Measured Parameters

- AC and DC current and voltage
- Active (Watts), reactive (VAR) and apparent (VA) power
- Frequency
- Power factor and phase angle
- Suppressed zero voltage for a narrow voltage range
- Tap position on a high voltage transformer
- Temperature transmitters for resistance thermometer detectors (RTD's)
- Resistance transmitters

Features

- Measurement of most electrical parameters
- Conversion to standard DC output signals
- Outputs suitable for indication, PLCs
- High accuracy
- Multiple outputs in single housing
- Exceptional waveforms handling
- Zero and span adjustments
- Single and three-phase systems
- Flame retardant cases
- Screw clamp terminals
- DIN-rail mounting

Benefits

- Cost savings remote metering
- Reduction of signal levels for ease of metering
- Isolated output for safety
- Protection against high voltage and overload

Applications

- Switchgear motor control centres, generating sets, energy management and building management systems

General Specifications

	Class 0.5 range	Class 0.2 range
Performance:	Designed to comply with BS6253 part 1, EN60688, IEC688, AS1384 and ANSI. C37	Designed to comply with BS6253 part 1, EN60688, IEC688, AS1384 and ANSI. C37
Temperature range:	Storage -20°C to +70°C operating 0°C to +60°C calibrated at 23°C	Storage -55°C to +85°C operating (-20 to +70 for 256-X) -10°C to +60°C, calibrated at 23°C
Temperature coefficient:	0.03%/per °C typical	0.01%/per °C typical
Humidity range:	Up to 95% RH	Up to 95% RH
Zero adjustment:	±2% minimum (except TAA & TVA)	±2% minimum
Span adjustment:	±10% minimum	±10% minimum
Accuracy class:	0.5 unless otherwise specified	0.2 unless otherwise specified
Accuracy range:	0 to 120% (except self powered)	0 to 120% (except self powered)
Stability:	+0.25% per annum typical (reducing with time)	+0.2% per annum typical (reducing with time)
Response time:	<400 ms from 0 to 99% of rated output, 250ms to 90%	<200ms from 0 to 99% of rated output, <400ms to 95% for 253-THZ
DC outputs (varies by model bipolar for some models):	0/1mA into 0-10kΩ 0/5mA into 0-2kΩ 0/10mA into 0-1kΩ 0/20mA into 0-500Ω 4/20mA into 0-500Ω 0/5V 1k ohm minimum load 0/10V 1K ohm minimum load	0/1mA into 0-15kΩ 0/5mA into 0-3kΩ 0/10mA into 0-1.5kΩ 0/20mA into 0-750Ω 4/20mA into 0-750Ω 0/5V 250 ohm minimum load 0/10V 500 ohm minimum load
Current output protection:	Fully protected against open and short circuited output	Fully protected against open and short circuited output
Voltage output protection:	Fully protected against open circuit output	Fully protected against open circuit output
Maximum output:	24V DC when open circuit	24V DC when open circuit
Output ripple:	<0.5% of full rated output	<0.5% of full rated output
Continuous overload capacity:	2 x rated current continuous 1.25 x rated voltage continuous	2 x rated current continuous 1.5 x rated voltage continuous
Short duration overload capacity:	20 x rated current for 1 second 1.5 x rated voltage for 10 seconds	20 x rated current for 1 second 2 x rated voltage for 1 second
Input burden:	AC <2 VA	AC <2 VA
Auxiliary burden:	<2 VA AC <3.5 W DC auxiliary voltage variation	<2 VA AC <3.5 W DC auxiliary voltage variation
Auxiliary permissible variation:	AC ±20%, DC ±15% including ripple, except wide range auxiliary A2: 12-48V DC, +25%, -15% (10.2V absolute minimum to 60V absolute maximum) A5: 100 to 250V AC ±15% 85V AC absolute minimum to 287V AC absolute maximum, 100V DC to 250V DC +25%, -15% (85V DC absolute minimum to 312V DC absolute maximum)	AC ±20%, DC ±20% including ripple
Safety:	To IEC1010 with terminal cover, basic insulation category	To IEC1010 with terminal cover, basic insulation category
Flammability:	Flame retardant enclosure to UL90-V0 (terminal cover UL90-V2)	Flame retardant enclosure to UL90-V0 (terminal cover UL90-V2)
Isolation:	Input/output/supply/case (except TRR, TRP, TRT and TRV with no input/output isolation)	Input/output/supply/case
Interference:	In accordance with IEC 61326	In accordance with IEC 61326
Input impedance: (DC I/P)	DC 1000 ohms/volt as standard 10k ohms/volt available on request	DC 1000 ohms/volt as standard 10k ohms/volt available on request

Current Transducers



AC Current Average Sensing - Auxiliary Powered

Single or three-phase models offering current measurement down to zero input. Average sensing and calibrated to indicate the RMS value of a sine wave with up to 1% distortion. Input, output and auxiliary are isolated.

Model	Accuracy	Function	Connection diagram
253-TAL	Class 0.5	AC current average sensing, 75mm(3") case	6
256-TAL	Class 0.5	AC current average sensing, 3-phase 3 DC outputs, 150mm(6") case	2
252-XAL	Class 0.2	AC current average sensing, 50mm(2") case	6

Specifications

Input:	1A, 5A or 10A AC
Output:	0/1mA, 0/5mA, 0/10mA, 0/20mA or 4/20mA DC 0/1V, 0/5V or 0/10V DC
Current:	1 or 5A AC
Frequency:	50Hz, 60Hz
Auxiliary*:	100-480V AC 12V, 24V, 48V, 110V or 125V DC

*Max AC Aux on 256-TAL is 300V



AC Current Average Sensing - Self Powered

Average sensing and calibrated to indicate the RMS value of a sine wave with less than 1% distortion. Internal power is derived from the input signal and will maintain accuracy to 20% of full scale or less. Input and output are isolated.

Model	Accuracy	Function	Connection diagram
253-TAA	Class 0.5	AC current average sensing, 75mm(3") case	1
252-XAA	Class 0.2	AC current average sensing, 50mm(2") case	1

Specifications

Input:	1A, 5A or 10A AC
Output:	0/1mA, 0/5mA, 0/10mA or 0/20mA DC 0/1V, 0/5V or 0/10V DC
Current:	1 or 5A AC
Frequency:	50Hz, 60Hz



True RMS Current - Auxiliary Powered

Single or three-phase models offering current measurement down to zero input. True RMS measurement of the input current, measuring non standard and distorted waveforms. Calibrated for sine waves with up to 30% of 3rd harmonic distortion. Isolation is provided between input, output and auxiliary.

Model	Accuracy	Function	Connection diagram
253-TAR	Class 0.5	AC current RMS sensing, 75mm(3") case	6
256-TAR	Class 0.5	AC current RMS sensing, 3-phase, 3 DC outputs, 150mm(6") case	2
252-XAR	Class 0.2	AC current RMS sensing, 50mm(2") case	6
256-XAR	Class 0.2	AC current RMS sensing, 3 phase, 3 DC outputs, 150mm(6") case	2

Specifications

Input:	1A, 5A or 10A AC
Output:	0/1mA, 0/5mA, 0/10mA, 0/20mA or 4/20mA DC 0/1V, 0/5V or 0/10V DC
Current:	1 or 5A AC
Frequency:	50Hz, 60Hz
Auxiliary*:	100-480V AC 12V, 24V, 48V, 110V or 125V DC

*Max AC Aux on 256-TAR is 300V

Voltage Transducers

AC Voltage Average Sensing - Auxiliary Powered

Single or three-phase models offering voltage measurement down to zero input. Average sensing and calibrated to indicate the RMS value of a sine wave with up to 1% distortion. Input, output and auxiliary are isolated.

Model	Accuracy	Function	Connection diagram
253-TVL	Class 0.5	AC voltage average sensing, 75mm(3") case	15
256-TVL	Class 0.5	AC voltage average sensing, 3-phase 3 DC outputs, 150mm(6") case	11
252-XVL	Class 0.2	AC voltage average sensing, 50mm(2") case	15

Specifications

Input*:	63.5V, 100V, 110V, 120V, 150V, 220V, 230V, 240V, 300V, 380V, 400V, 415V, 440V, 480V, 500V & 600V AC
Output:	0/1mA, 0/5mA, 0/10mA, 0/20mA or 4/20mA DC 0/1V, 0/5V or 0/10V DC
Current:	1 or 5A AC
Frequency:	50Hz, 60Hz
Auxiliary*:	100-480V AC 12V, 24V, 48V, 110V or 125V DC

*Max AC input & Aux on 256-TVL is 300V

AC Voltage Average Sensing - Self Powered

Average sensing and calibrated to indicate the RMS value of a sine wave with less than 1% distortion. Internal power is derived from the input signal and will maintain accuracy down to 20% of full scale. Input and output are isolated.

Model	Accuracy	Function	Connection diagram
253-TVA	Class 0.5	AC voltage average sensing, 75mm(3") case	10
252-XVA	Class 0.2	AC voltage average sensing, 50mm(2") case	10

Specifications

Input:	63.5V, 100V, 110V, 120V, 150V, 220V, 230V, 240V, 300V, 380V, 400V, 415V, 440V, 480V, 500V & 600V AC
Output:	0/1mA, 0/5mA, 0/10mA or 0/20mA (DC 0/1V, 0/5V or 0/10V DC available on special request)
Current:	1 or 5A AC
Frequency:	50Hz, 60Hz

True RMS Voltage - Auxiliary Powered

Single or three-phase models offering voltage measurement down to zero input. True RMS measurement of the input voltage, measuring non standard and distorted waveforms. Calibrated for sine waves with up to 30% of 3rd harmonic distortion. Isolation is provided between input, output and auxiliary.

Model	Accuracy	Function	Connection diagram
253-TVR	Class 0.5	AC voltage RMS sensing, 75mm(3") case	15
256-TVR	Class 0.5	AC voltage RMS sensing, 3-phase, 3 DC outputs, 150mm(6") case	11
252-XVR	Class 0.2	AC voltage RMS sensing, 50mm(2") case	15
256-XVR	Class 0.2	AC voltage RMS sensing, 3 phase 4 wire, 3 DC outputs, 150mm(6") case	15

Specifications

Input*:	63.5V, 100V, 110V, 120V, 150V, 220V, 230V, 240V, 300V, 380V, 400V, 415V, 440V, 480V, 500V & 600V AC
Output:	0/1mA, 0/5mA, 0/10mA, 0/20mA or 4/20mA DC 0/1V, 0/5V or 0/10V DC
Current:	1 or 5A AC
Frequency:	50Hz, 60Hz
Auxiliary*:	100-480V AC 12V, 24V, 48V, 110V or 125V DC

*Max AC input & Aux on 256-TVR is 300V

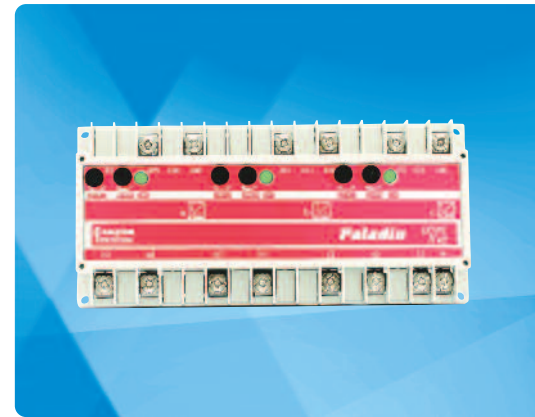



AC Voltage Suppressed Zero – Auxiliary or Self Powered

Single or three-phase models offering ‘expanded scale’ measurements at critical voltage levels, indicating small changes within a large voltage span. Average sensing and calibrated to indicate the RMS value of a sine wave less than 1% distortion. Isolation is provided between input, output and auxiliary.

Model	Accuracy	Function	Connection diagram
253-TVZ	Class 0.5	AC voltage RMS sensing suppressed zero, 50mm(2") case - self powered	15
256-XVZ	Class 0.2	AC voltage RMS sensing suppressed zero, 3-phase 4-wire, 3 DC outputs, 150mm(6") case - auxiliary powered	15

Specifications

Input*:	Between +/-10% and +/-30% of nominal 63.5V, 100V, 110V, 120V, 139V, 208V, 220V, 240V, 250V, 277V, 380V, 400V, 415V, 440V, & 480V AC
Output:	0/1mA, 0/5mA, 0/10mA or 0/20mA DC 0/1V, 0/5V or 0/10V DC
Current:	1 or 5A AC
Frequency:	50Hz, 60Hz
Auxiliary:	100-480V AC 12V, 24V, 48V, 110V or 125V DC



Frequency Transducers

Frequency Sensing - Self Powered

Provides a DC output which is directly proportional to input frequency. Internal power is derived from the input signal and will maintain accuracy between 80% and 120% or better of nominal input voltage. Input and output are isolated.

Model	Accuracy	Function	Connection diagram
253-THZ	Class 0.5	Frequency sensing, 75mm(3") case	10
252-XHA	Class 0.2	Frequency sensing, 50mm(2") case	10

Specifications

Input:	63.5V, 100V, 110V, 120V, 139V, 208V, 220V, 240V, 250V, 277V, 380V, 400V, 415V, 440V, & 480V AC
Output:	0/1mA, 0/5mA, 0/10mA or 0/20mA DC 0/1V, 0/5V or 0/10V DC
Current:	1 or 5A AC
Frequency:	45/55Hz, 55/65Hz, 45/65Hz & 360/440Hz

Frequency Sensing - Auxiliary Powered

Provides a DC output which is directly proportional to input frequency. Internal power is derived from the input signal and will maintain accuracy whilst the auxiliary input is within specification limits. 253-THZ offers AC auxiliary and 252-THL/Z caters for both AC and DC auxiliary. Isolation is provided between input, output and auxiliary.

Model	Accuracy	Function	Connection diagram
252-THL	Class 0.2	Frequency sensing, live zero 50mm(2") case	15
252-THS	Class 0.2	Frequency sensing, true zero 50mm(2") case	15

Specifications

Input:	63.5V, 100V, 110V, 120V, 139V, 208V, 220V, 240V, 250V, 277V, 380V, 400V, 415V, 440V, & 480V AC
Output:	0/1mA, 0/5mA, 0/10mA or 0/20mA DC 0/1V, 0/5V or 0/10V DC
Current:	1 or 5A AC
Frequency:	45/55Hz, 55/65Hz, 45/65Hz
Auxiliary:	100-480V AC 12V, 24V, 48V, 110V or 125V DC

Power Transducers

Watt Transducers – Auxiliary or Self Powered

A range of Watt transducers in single or three-phase, balanced or unbalanced, 3 or 4-wire systems. Class 0.5 products utilise the well established 'time division multiplication' method of measuring power while the class 0.2 products are microprocessor based and offer exceptional waveform handling on distorted waveforms. In the self powered products the system voltage provides both power supply and input to the measurements circuit but for systems with large voltage variations auxiliary powered products should be used. Input, output and auxiliaries are isolated.



Model	Accuracy	Function	Connection diagram
256-TWK	Class 0.5	1-phase, 150mm(6") case	14
256-TWL	Class 0.5	3-phase 3-wire balanced load, 150mm(6") case	19
256-TWH	Class 0.5	3-phase 4-wire balanced load, 150mm(6") case	24
256-TWM	Class 0.5	3-phase 3-wire unbalanced load, 150mm(6") case	20
256-TWN	Class 0.5	3-phase 4-wire unbalanced load, 150mm(6") case	35
256-TWS	Class 0.5	3-phase 3-wire balanced load (2 voltage connections), 150mm(6") case	38
256-XWK	Class 0.2	1 phase, 150mm(6") case	14
256-XWL	Class 0.2	3 phase 3 wire balanced load, 150mm(6") case	41
256-XWH	Class 0.2	3-phase 4-wire balanced load, 150mm(6") case	24
256-XWM	Class 0.2	3-phase 3-wire unbalanced load, 150mm(6") case	20
256-XWW	Class 0.2	3-phase 4-wire unbalanced load, 150mm(6") case	21

Specifications

Input:	57.7V, 63.5V, 100V, 110V, 120V, 139V, 208V, 220V, 240V, 250V, 277V, 380V, 400V, 415V, 440V, & 480V AC
Output:	0/1mA, 0/5mA, 0/10mA, 0/20mA or 4/20mA DC 1/0/1mA, 5/0/5mA, 10/0/10mA or 20/0/20mA DC 0/1V, 0/5V or 0/10V DC 1/0/1V, 5/0/5V or 10/0/10V DC
Current:	1 or 5A AC
Frequency:	50Hz, 60Hz
Optional	100-480V AC
Auxiliary:	12V, 24V, 48V, 110V or 125V DC



VAR Transducers - Auxiliary or Self Powered

A range of VAR transducers in single or three-phase, balanced or unbalanced, 3 or 4-wire systems. Class 0.5 products utilise the well established 'time division multiplication' method of measuring power while the class 0.2 products are microprocessor based and offer exceptional waveform handling on distorted waveforms. In the self powered products the system voltage provides both power supply and input to the measurements circuit but for systems with large voltage variations auxiliary powered products should be used. Input, output and auxiliaries are isolated.

Model	Accuracy	Function	Connection diagram
256-TXK	Class 0.5	1-phase, 150mm(6") case	14
256-TXG	Class 0.5	3-phase 3-wire balanced load, 150mm(6") case	41
256-TXH	Class 0.5	3-phase 4-wire balanced load, 150mm(6") case	42
256-TXM	Class 0.5	3-phase 3-wire unbalanced load, 150mm(6") case	20
256-TXN	Class 0.5	3-phase 4-wire unbalanced load, 150mm(6") case	40
256-XXK	Class 0.2	1 phase, 150mm(6") case	14
256-XXL	Class 0.2	3 phase 3 wire balanced load, 150mm(6") case	41
256-XXH	Class 0.2	3-phase 4-wire balanced load, 150mm(6") case	24
256-XXM	Class 0.2	3-phase 3-wire unbalanced load, 150mm(6") case	20
256-XXW	Class 0.2	3 phase 4 wire unbalanced load, 150mm(6") case	21

Specifications

Input:	57.7V, 63.5V, 100V, 110V, 120V, 139V, 208V, 220V, 240V, 250V, 277V, 380V, 400V, 415V, 440V, & 480V AC
Output:	0/1mA, 0/5mA, 0/10mA, 0/20mA or 4/20mA DC 1/0/1mA, 5/0/5mA, 10/0/10mA or 20/0/20mA DC 0/1V, 0/5V or 0/10V DC 1/0/1V, 5/0/5V or 10/0/10V DC
Current:	1 or 5A AC
Frequency:	50Hz, 60Hz
Optional	100-480V AC
Auxiliary:	12V, 24V, 48V, 110V or 125V DC

VA Transducers - Auxiliary or Self Powered

A range of VA transducers in single or three-phase, balanced or unbalanced, 3 or 4-wire systems. Class 0.5 products utilise the well established 'time division multiplication' method of measuring power while the class 0.2 products are microprocessor based and offer exceptional waveform handling on distorted waveforms. In the self powered products the system voltage provides both power supply and input to the measurements circuit but for systems with large voltage variations auxiliary powered products should be used. Input, output and auxiliaries are isolated.

Model	Accuracy	Function	Connection diagram
256-TYK	Class 0.5	1-phase, 150mm(6") case	14
256-TYG	Class 0.5	3-phase 3-wire balanced load, 150mm(6") case	41
256-TYH	Class 0.5	3-phase 4-wire balanced load, 150mm(6") case	42
256-TYM	Class 0.5	3-phase 3-wire unbalanced load, 150mm(6") case	20
256-TYN	Class 0.5	3-phase 4-wire unbalanced load, 150mm(6") case	35
256-XYK	Class 0.2	1 phase, 150mm(6") case	14
256-XYL	Class 0.2	3 phase 3 wire balanced load, 150mm(6") case	41
256-XYH	Class 0.2	3 phase 4 wire balanced load, 150mm(6") case	24
256-XYM	Class 0.2	3-phase 3-wire unbalanced load, 150mm(6") case	20
256-XYW	Class 0.2	3 phase 4 wire unbalanced load, 150mm(6") case	21

Specifications

Input:	57.7V, 63.5V, 100V, 110V, 120V, 139V, 208V, 220V, 240V, 250V, 277V, 380V, 400V, 415V, 440V, & 480V AC
Output:	0/1mA, 0/5mA, 0/10mA, 0/20mA or 4/20mA DC 1/0/1mA, 5/0/5mA, 10/0/10mA or 20/0/20mA DC 1/0/1V, 5/0/5V or 10/0/10V DC (on request) 0/1V, 0/5V or 0/10V DC (on request)
Current:	1 or 5A AC
Frequency:	50Hz, 60Hz
Optional	100-480V AC
Auxiliary:	12V, 24V, 48V, 110V or 125V DC

Power Factor (2 Quadrant) Transducers - Auxiliary or Self Powered

A range of Power Factor (2 Quadrant) transducers in single or three-phase, balanced or unbalanced, 3 or 4-wire systems. All are class 0.2 accurate and microprocessor based to offer exceptional waveform handling on distorted waveforms. In the self powered products the system voltage provides both power supply and input to the measurements circuit but for systems with large voltage variations auxiliary powered products should be used. Input, output and auxiliaries are isolated.

Model	Accuracy	Function	Connection diagram
256-XFS	Class 0.2	1 phase, 150mm(6") case	14
256-XFW	Class 0.2	3-phase 3-wire balanced load, 150mm(6") case	19
256-XFV	Class 0.2	3-phase 4-wire balanced load, 150mm(6") case	24
256-XFU	Class 0.2	3-phase 3-wire unbalanced load, 150mm(6") case	20
256-XFT	Class 0.2	3-phase 4-wire unbalanced load, 150mm(6") case	21



Specifications

Input:	57.7V, 63.5V, 100V, 110V, 120V, 139V, 208V, 220V, 240V, 250V, 277V, 380V, 400V, 415V, 440V, & 480V AC
Output:	0/1mA, 0/5mA, 0/10mA, 0/20mA or 4/20mA DC 1/0/1mA, 5/0/5mA, 10/0/10mA or 20/0/20mA DC 0/1V, 0/5V or 0/10V DC 1/0/1V, 5/0/5V or 10/0/10V DC
Current:	1 or 5A AC
Frequency:	50Hz, 60Hz
Optional	100-480V AC
Auxiliary:	12V, 24V, 48V, 110V or 125V DC

Power Factor (4 Quadrant) Transducers - Auxiliary or Self Powered

A range of Power Factor (4 Quadrant) transducers in single or three-phase, balanced or unbalanced, 3 or 4-wire systems. All are class 0.2 accurate and microprocessor based to offer exceptional waveform handling on distorted waveforms. In the self powered products the system voltage provides both power supply and input to the measurements circuit but for systems with large voltage variations auxiliary powered products should be used. Input, output and auxiliaries are isolated.

Model	Accuracy	Function	Connection diagram
256-XFA	Class 0.2	1 phase, 150mm(6") case	14
256-XFG	Class 0.2	3-phase 3-wire balanced load, 150mm(6") case	19
256-XFD	Class 0.2	3-phase 4-wire balanced load, 150mm(6") case	24
256-XFC	Class 0.2	3-phase 3-wire unbalanced load, 150mm(6") case	20
256-XFB	Class 0.2	3-phase 4-wire unbalanced load, 150mm(6") case	21

Specifications

Input:	57.7V, 63.5V, 100V, 110V, 120V, 139V, 208V, 220V, 240V, 250V, 277V, 380V, 400V, 415V, 440V, & 480V AC
Output:	0/1mA, 0/5mA, 0/10mA, 0/20mA or 4/20mA DC 1/0/1mA, 5/0/5mA, 10/0/10mA or 20/0/20mA DC 0/1V, 0/5V or 0/10V DC 1/0/1V, 5/0/5V or 10/0/10V DC
Current:	1 or 5A AC
Frequency:	50Hz, 60Hz
Optional	100-480V AC
Auxiliary:	12V, 24V, 48V, 110V or 125V DC

Phase Angle (2 Quadrant) Transducers - Auxiliary or Self Powered

A range of Phase Angle (2 Quadrant) transducers in single or three-phase, balanced or unbalanced, 3 or 4-wire systems. All are class 0.2 accurate and microprocessor based to offer exceptional waveform handling on distorted waveforms. In the self powered products the system voltage provides both power supply and input to the measurements circuit but for systems with large voltage variations auxiliary powered products should be used. Input, output and auxiliaries are isolated.

Model	Accuracy	Function	Connection diagram
256-XPS	Class 0.2	1-phase, 150mm(6") case	14
256-XPW	Class 0.2	3 phase 3-wire balanced load, 150mm(6") case	19
256-XPV	Class 0.2	3 phase 4-wire balanced load, 150mm(6") case	24
256-XPU	Class 0.2	3 phase 3-wire unbalanced load, 150mm(6") case	20
256-XPT	Class 0.2	3-phase 4-wire unbalanced load, 150mm(6") case	21

Specifications

Input:	57.7V, 63.5V, 100V, 110V, 120V, 139V, 208V, 220V, 240V, 250V, 277V, 380V, 400V, 415V, 440V, & 480V AC
Output:	0/1mA, 0/5mA, 0/10mA, 0/20mA or 4/20mA DC 1/0/1mA, 5/0/5mA, 10/0/10mA or 20/0/20mA DC 0/1V, 0/5V or 0/10V DC 1/0/1V, 5/0/5V or 10/0/10V DC
Current:	1 or 5A AC
Frequency:	50Hz, 60Hz
Optional	100-480V AC
Auxiliary:	12V, 24V, 48V, 110V or 125V DC

Phase Angle (4 Quadrant) Transducers - Auxiliary or Self Powered

A range of Phase Angle (4 Quadrant) transducers in single or three-phase, balanced or unbalanced, 3 or 4-wire systems. All are class 0.2 accurate and microprocessor based to offer exceptional waveform handling on distorted waveforms. In the self powered products the system voltage provides both power supply and input to the measurements circuit but for systems with large voltage variations auxiliary powered products should be used. Input, output and auxiliaries are isolated.

Model	Accuracy	Function	Connection diagram
256-XPA	Class 0.2	1-phase, 150mm(6") case	14
256-XPG	Class 0.2	3-phase 3-wire balanced load, 150mm(6") case	19
256-XPD	Class 0.2	3-phase 4-wire balanced load, 150mm(6") case	24
256-XPC	Class 0.2	3-phase 3-wire unbalanced load, 150mm(6") case	20
256-XPB	Class 0.2	3-phase 4-wire unbalanced load,	21

Specifications

Input:	57.7V, 63.5V, 100V, 110V, 120V, 139V, 208V, 220V, 240V, 250V, 277V, 380V, 400V, 415V, 440V, & 480V AC
Output:	0/1mA, 0/5mA, 0/10mA, 0/20mA or 4/20mA DC 1/0/1mA, 5/0/5mA, 10/0/10mA or 20/0/20mA DC 0/1V, 0/5V or 0/10V DC 1/0/1V, 5/0/5V or 10/0/10V DC
Current:	1 or 5A AC
Frequency:	50Hz, 60Hz
Optional	100-480V AC
Auxiliary:	12V, 24V, 48V, 110V or 125V DC

Combined Power Transducers

Combined Watt & VAR Transducers - Auxiliary or Self Powered

A range of combined Watt & VAR transducers in single or three-phase, balanced or unbalanced, 3 or 4-wire systems. All are class 0.2 accurate and microprocessor based to offer exceptional waveform handling on distorted waveforms. In the self powered products the system voltage provides both power supply and input to the measurements circuit but for systems with large voltage variations auxiliary powered products should be used. Input, output and auxiliaries are isolated.

Model	Accuracy	Function	Connection diagram
256-XDK	Class 0.2	1-phase, 150mm(6") case	14
256-XDL	Class 0.2	3-phase 3-wire balanced load, 150mm(6") case	25
256-XDH	Class 0.2	3-phase 4-wire balanced load, 150mm(6") case	26
256-XDM	Class 0.2	3-phase 3-wire unbalanced load, 150mm(6") case	22
256-XDW	Class 0.2	3-phase 4-wire unbalanced load, 150mm(6") case	23

Specifications

Input:	57.7V, 63.5V, 100V, 110V, 120V, 139V, 208V, 220V, 240V, 250V, 277V, 380V, 400V, 415V, 440V, & 480V AC
Output:	0/1mA, 0/5mA, 0/10mA, 0/20mA or 4/20mA DC 1/0/1mA, 5/0/5mA, 10/0/10mA or 20/0/20mA DC 0/1V, 0/5V or 0/10V DC 1/0/1V, 5/0/5V or 10/0/10V DC
Current:	1 or 5A AC
Frequency:	50Hz, 60Hz
Optional	100-480V AC
Auxiliary:	12V, 24V, 48V, 110V or 125V DC



Combined Watt, VAR & VA Transducers - Auxiliary or Self Powered

A range of combined Watt, VAR & VA transducers in single or three-phase, balanced or unbalanced, 3 or 4-wire systems. All are class 0.2 accurate and microprocessor based to offer exceptional waveform handling on distorted waveforms. In the self powered products the system voltage provides both power supply and input to the measurements circuit but for systems with large voltage variations auxiliary powered products should be used. Input, output and auxiliaries are isolated.

Model	Accuracy	Function	Connection diagram
256-XEK	Class 0.2	1-phase, 150mm(6") case	14
256-XRL	Class 0.2	3-phase 3-wire balanced load, 150mm(6") case	27
256-XRH	Class 0.2	3-phase 4-wire balanced load, 150mm(6") case	28
256-XRM	Class 0.2	3-phase 3-wire unbalanced load, 150mm(6") case	31
256-XRW	Class 0.2	3-phase 4-wire unbalanced load, 150mm(6") case	32

Specifications

Input:	57.7V, 63.5V, 100V, 110V, 120V, 139V, 208V, 220V, 240V, 250V, 277V, 380V, 400V, 415V, 440V, & 480V AC
Output:	0/1mA, 0/5mA, 0/10mA, 0/20mA or 4/20mA DC 1/0/1mA, 5/0/5mA, 10/0/10mA or 20/0/20mA DC 1/0/1V, 5/0/5V or 10/0/10V DC
Current:	1 or 5A AC
Frequency:	50Hz, 60Hz
Optional	100-480V AC
Auxiliary:	12V, 24V, 48V, 110V or 125V DC





Combined Watt, VAR & Power Factor (2 Quadrant) Transducers - Auxiliary or Self Powered

A range of combined Watt, VAR & Power Factor (2 Quadrant) transducers in single or three-phase, balanced or unbalanced, 3 or 4-wire systems. All are class 0.2 accurate and microprocessor based to offer exceptional waveform handling on distorted waveforms. In the self powered products the system voltage provides both power supply and input to the measurements circuit but for systems with large voltage variations auxiliary powered products should be used. Input, output and auxiliaries are isolated.

Model	Accuracy	Function	Connection diagram
256-XGK	Class 0.2	1 phase, 150mm(6") case	14
256-XSL	Class 0.2	3-phase 3-wire balanced load, 150mm(6") case	27
256-XSH	Class 0.2	3 phase 4 wire balanced load, 150mm(6") case	28
256-XSM	Class 0.2	3-phase 3-wire unbalanced load, 150mm(6") case	31
256-XSW	Class 0.2	3-phase 4-wire unbalanced load, 150mm(6") case	32

Specifications

Input:	57.7V, 63.5V, 100V, 110V, 120V, 139V, 208V, 220V, 240V, 250V, 277V, 380V, 400V, 415V, 440V, & 480V AC
Output:	0/1mA, 0/5mA, 0/10mA, 0/20mA or 4/20mA DC 1/0/1mA, 5/0/5mA, 10/0/10mA or 20/0/20mA DC 0/1V, 0/5V or 0/10V DC 1/0/1V, 5/0/5V or 10/0/10V DC
Current:	1 or 5A AC
Frequency:	50Hz, 60Hz
Optional	100-480V AC
Auxiliary:	12V, 24V, 48V, 110V or 125V DC

Combined Watt, VAR & Power Factor (4 Quadrant) Transducers - Auxiliary or Self Powered

A range of combined Watt, VAR & Power Factor (4 Quadrant) transducers in single or three-phase, balanced or unbalanced, 3 or 4-wire systems. All are class 0.2 accurate and microprocessor based to offer exceptional waveform handling on distorted waveforms. In the self powered products the system voltage provides both power supply and input to the measurements circuit but for systems with large voltage variations auxiliary powered products should be used. Input, output and auxiliaries are isolated.

Model	Accuracy	Function	Connection diagram
256-XJL	Class 0.2	3-phase 3-wire balanced load, 150mm(6") case	27
256-XJH	Class 0.2	3 phase 4 wire balanced load, 150mm(6") case	28
256-XJM	Class 0.2	3 phase 3 wire unbalanced load, 150mm(6") case	31
256-XJW	Class 0.2	3 phase 4 wire unbalanced load, 150mm(6") case	32

Specifications

Input:	57.7V, 63.5V, 100V, 110V, 120V, 139V, 208V, 220V, 240V, 250V, 277V, 380V, 400V, 415V, 440V, & 480V AC
Output:	0/1mA, 0/5mA, 0/10mA, 0/20mA or 4/20mA DC 1/0/1mA, 5/0/5mA, 10/0/10mA or 20/0/20mA DC 0/1V, 0/5V or 0/10V DC 1/0/1V, 5/0/5V or 10/0/10V DC
Current:	1 or 5A AC
Frequency:	50Hz, 60Hz
Optional	100-480V AC
Auxiliary:	12V, 24V, 48V, 110V or 125V DC

DC/DC Transducers

DC/DC Transducers - Auxiliary Powered

A range of DC/DC transducers that provide an output directly proportional to the input. Suitable for data acquisition and data control monitoring. Input, output and auxiliaries are isolated.

Model	Accuracy	Function	Connection diagram
256-TTA	Class 0.5	DC current, 150mm(6") case	18
256-TTM	Class 0.5	DC millivolts, 150mm(6") case	18
256-TTV	Class 0.5	DC voltage, 150mm(6") case	18

Specifications

Input:	DC current: 200 μ A to 10A DC DC millivolts: 10mV to 2V DC DC voltage: 2V to 600V DC
Output:	0/1mA, 0/5mA, 0/10mA, 0/20mA or 4/20mA DC 1/0/1mA, 5/0/5mA, 10/0/10mA or 20/0/20mA DC 0/1V, 0/5V or 0/10V DC 1/0/1V, 5/0/5V or 10/0/10V DC
Current:	1 or 5A AC
Optional	100-480V AC
Auxiliary:	12V, 24V, 48V, 110V or 125V DC



Thermocouple Transducers

Thermocouple (Temperature) Transducers - Auxiliary Powered

A range of transducers for Type T, J & K Thermocouples that provide an output directly proportional to the input. All models incorporate cold junction compensation for all base metal thermocouples and thermocouple break protection. Input, output and auxiliaries are isolated.

Model	Accuracy	Function	Connection diagram
256-TTC	Class 0.5	Type T thermocouple, 150mm(6") case	18
256-TTF	Class 0.5	Type J thermocouple, 150mm(6") case	18
256-TTN	Class 0.5	Type K thermocouple, 150mm(6") case	18

Specifications

Input:	Type T: 0°C to 400°C Type J: 0°C to 700°C Type K: 0°C to 1200°C
Output:	0/1mA, 0/5mA, 0/10mA, 0/20mA or 4/20mA DC 1/0/1mA, 5/0/5mA, 10/0/10mA or 20/0/20mA DC 0/1V, 0/5V or 0/10V DC 1/0/1V, 5/0/5V or 10/0/10V DC
Current:	1 or 5A AC
Optional	100-480V AC
Auxiliary:	12V, 24V, 48V, 110V or 125V DC

Tap Position Transducers



Tap Position Transducer - Auxiliary Powered

For accurate remote indication of tap position selection on a high voltage transformer. The variable tap position voltage is monitored, and a DC output produced which is proportional to the tap position. Input, output and auxiliaries are isolated.

Model	Accuracy	Function	Connection diagram
253-TRT	Class 0.5	Tap position, 75mm(3") case	12

Specifications

Input:	1K Ω to 20K Ω 5-50 taps at 400 Ω each 10-50 taps at 30 Ω each
Output:	0/1mA, 0/5mA, 0/10mA, 0/20mA or 4/20mA DC
Current:	1 or 5A AC
Optional	100-480V AC
Auxiliary:	12V, 24V, 48V, 110V or 125V DC



Resistance Transducers

Resistance Transducer - Auxiliary Powered

A simple and convenient way of measuring and transmitting temperature values in the form of a load independent DC signal. Transmitters detect varying resistance due to temperature change at the RTD (Resistance Temperature Detector). Designed for platinum (Pt.100), copper (Cu 10) or nickel (Ni100) RTDs. Input, output and auxiliaries are isolated.

Model	Accuracy	Function	Connection diagram
253-TRR	Class 0.5	Resistance, 75mm(3") case	17

Specifications

Input:	100 Ω Platinum (Pt 100) 10 Ω Copper (Cu 10) 100 Ω Nickel (Ni 100)
Output:	0/1mA, 0/5mA, 0/10mA, 0/20mA or 4/20mA DC
Current:	1 or 5A AC
Optional	100-480V AC
Auxiliary:	12V, 24V, 48V, 110V or 125V DC



Single Isolator

Single Frequency Transducers - Self Powered, 1 DC

The signal isolator is designed for use in signal transmission and processing applications to prevent noise and interference caused by ground loops between signal source and the measuring device. The isolator provides galvanic high voltage isolation between the source and measuring device.

Model	Accuracy	Function	Connection diagram
250-ISA	Class 0.2	Signal Isolator	5

Specifications

Input/output ratio:	1 to 1
Max Input/output:	20mA DC
Isolation:	660V AC, 930V DC continuous
Load range:	0-500 ohms @ 20mA DC
Output voltage:	1 out x R Load limited to 15V
Input voltage:	Typically 1 x (load + 200 Ω) limited to 18V

Paladin Transducers 250 Series

Dimensions

Model 250

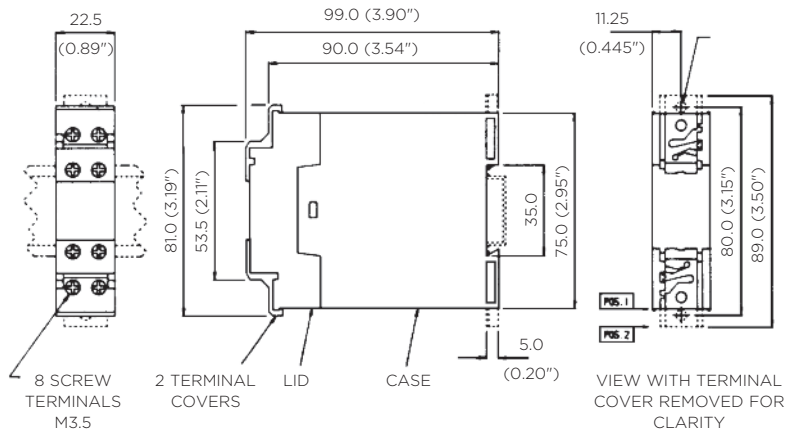

Model 252

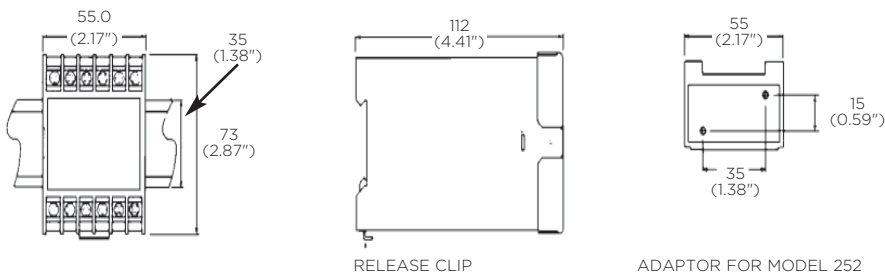

Model 253, 256

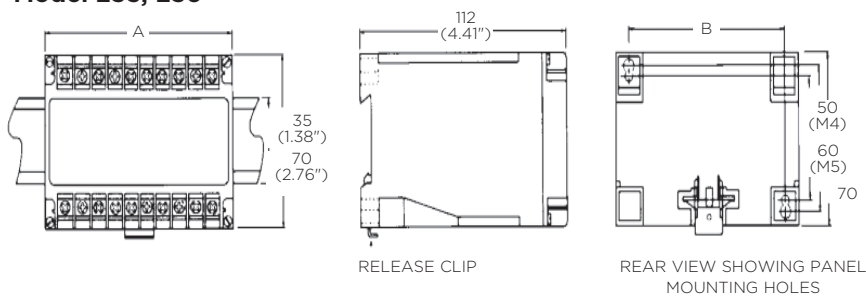

Model	A mm	A inches	B mm	B inches
250	22.5	0.88	-	-
252	55	2.17	-	-
253	75	2.96	60	2.36
256	150	5.90	135	5.31

The signal isolator is designed for use in signal transmission and processing applications to prevent noise and interference caused by ground loops between signal source and the measuring device. The isolator provides galvanic high voltage isolation between the source and measuring device.

Connection Diagrams

Type 252-XAA, Type 253-TAA

Single-phase Current, Self Powered – Diagram 1

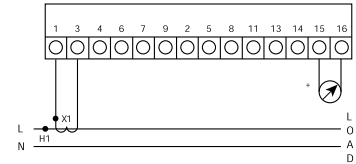
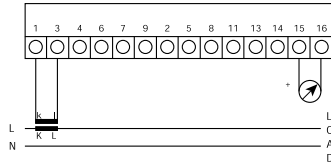

Type 256-XAS/XAR, Type 256-TAS, TAL, TAR

3 Ø Current, 3 Outputs – Diagram 2

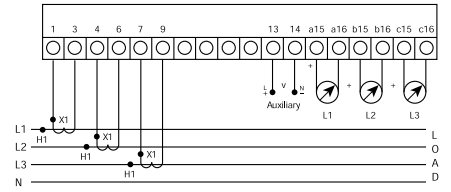
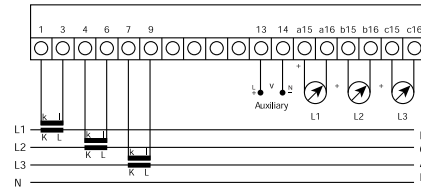

Type 250-ISA

Signal Isolator – Diagram 5



Type 252-XAS/XAR/XAL, Type 253-TAL/TAR

Single-phase Current – Diagram 6

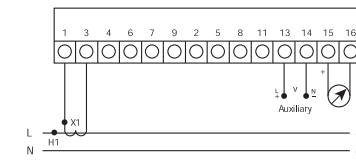
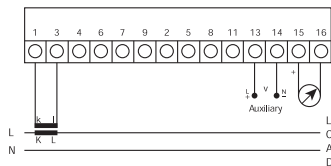

Type 256-XLK

Voltage, Current and Frequency, 3 Outputs – Diagram 9

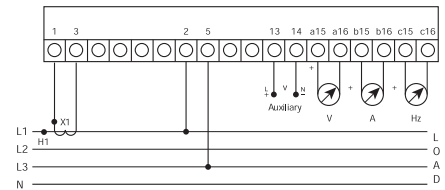
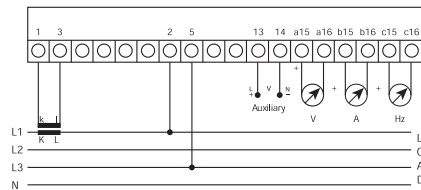

Type 252-XVA & Type 253-TVA

Single-phase Voltage Self Powered

Type 252-XHA, 253-THZ

Frequency – Diagram 10

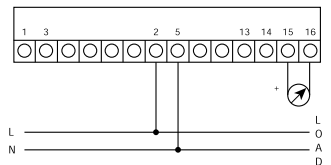

Type 253-TRT

Tap Position Diagram 12

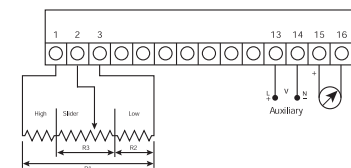

Type 256-TVL, TVR, TVS, TVW Type 256-XVU, XVW, XVY, XVX

3 x 1Ø Voltages 3 Outputs – Diagram 11

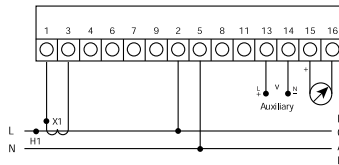
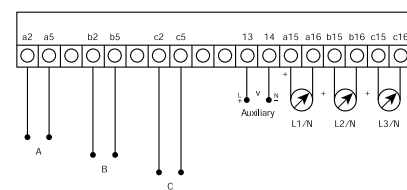

Type 256-XWK/XXK/XYK/XDK /XEK/XGK/XFS/XFA/XPS/XPA Type 256-TWK/TXK/TYK

Single-phase, Watts or VARs or VA or Phase Angle or Power Factor, Watt and VAR: Watt, VAR and VA: Watt, VAR and Power Factor. One Output – Diagram 14

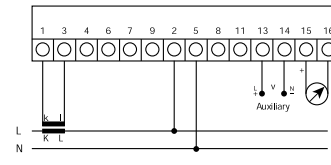

Type 252-XVS, XVZ, XVR, XVL, XHL, XHS

Type 253-TVL, TVR, TVZ

Single-phase Voltage – Diagram 15

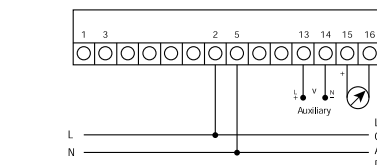

Type 256-XVS/XVR/XVZ/XVL

3 Ø 4W Voltage, 3 Outputs – Diagram 16

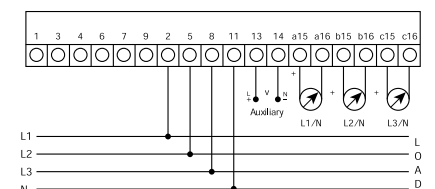

Type 253-TRR

Temperature Transmitter – Diagram 17

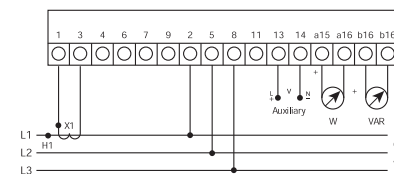
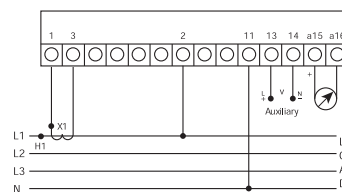
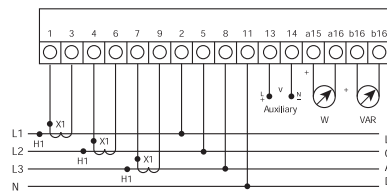
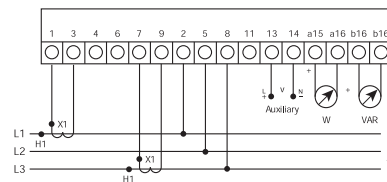
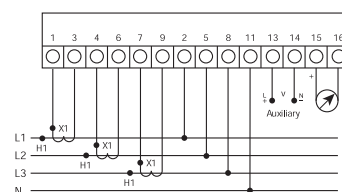
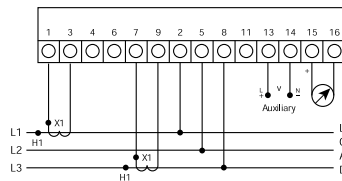
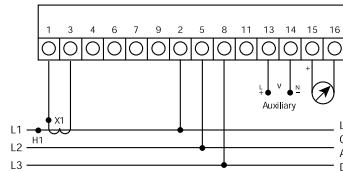
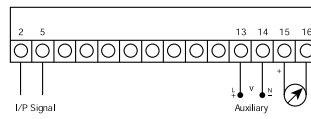
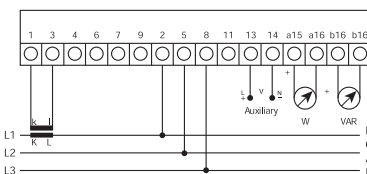
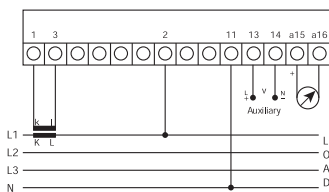
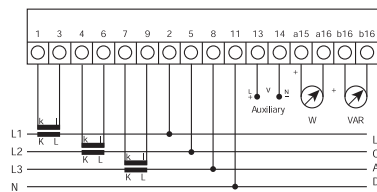
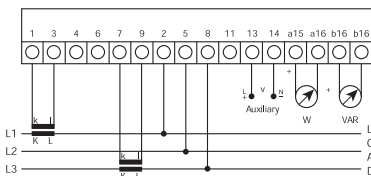
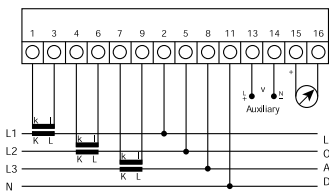
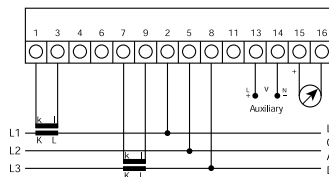
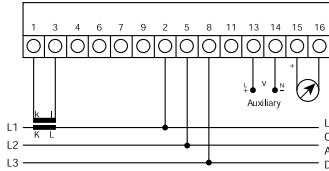
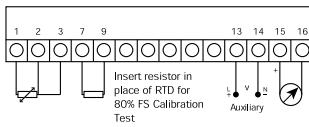

Type 256-TTA/M/V/F/C/N

DC/DC Transducer and Temperature Diagram 18

Type 256-XWL/XXL/XYL/XFW/XPW/XPG/XFG

Type 256-TWL/TPB/TFB/TFE
3 Ø 3W Balanced Load, Watts or VArS or VA or Phase Angle or Power Factor. One Output – Diagram 19

Type 256-XWM/XXM/XYM/XZM/XFU/XFC/XPU/XPC

Type 256-TWM/TXM/TYM
3 Ø 3W Unbalanced Load, Watts or VArS or VA or Phase Angle or Power Factor. One Output – Diagram 20

Type 256-XWW/XXW/XYW/XZW/XFT/XFB/XPT/XPB

3 Ø 4W Unbalanced Load, 3 Elements, Watts or VArS or VA or Phase Angle or Power Factor. One Output – Diagram 21

Type 256-XDM

3 Ø 3W Unbalanced Load, Watt and VAR, 2 Outputs – Diagram 22

Type 256-XDW

3 Ø 4W Unbalanced Load, 3 Elements, Watt and VAR, 2 Outputs – Diagram 23

Type 256-XWH/XXH/XYH/XFV/XFD/XPV/XPD

Type 256-TWH/TXH/TYH
3 Ø 4W Balanced Load, Watt, VAR and VA or Phase Angle or Power Factor. 1 Output – Diagram 24

Type 256-XDL

3 Ø 3W Balanced Load, Watt and VAR, 2 Outputs – Diagram 25

Type 256-XDH

3 Ø 4W Balanced Load, Watt and VAR, 2 Outputs - Diagram 26

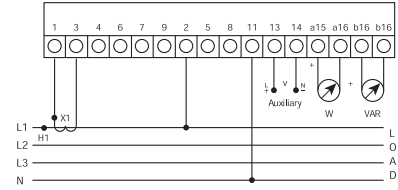
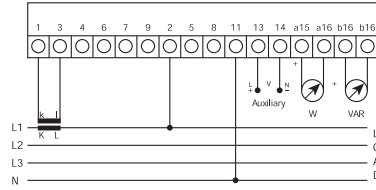

Type 256-XRL/XSL/XJL

3 Ø 3W Balanced Load, Watt, VAR and VA: Watt, VAR and Power Factor. 3 Outputs - Diagram 27

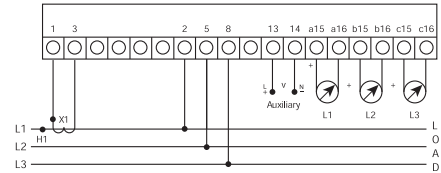
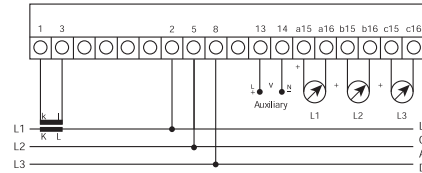

Type 256-XRH/XSH/XJH

3 Ø 4W Balanced Load, Watt, VAR and VA: Watt, VAR and Power Factor. 3 Outputs - Diagram 28

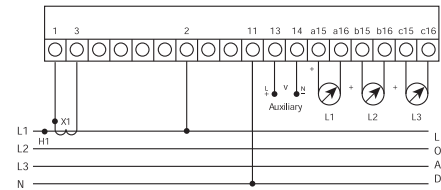
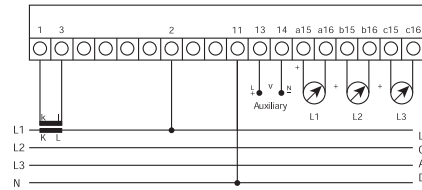

Type 256-XWE/XXE/XYE/XFE/XFF/XPE/XPF

3 Ø 4W Unbalanced Load, Watt, VAR and VA or Phase Angle or Power Factor. 3 Outputs - Diagram 29

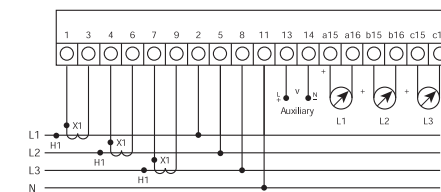
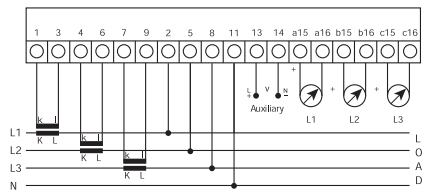

Type 256-XRM/XSM/XJM

3 Ø 3W Unbalanced Load, Watt, VAR and VA: Watt, VAR and Power Factor. 3 Outputs - Diagram 31

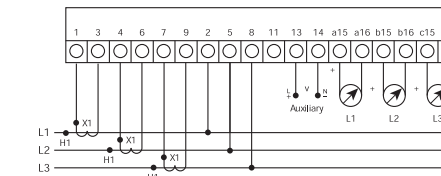
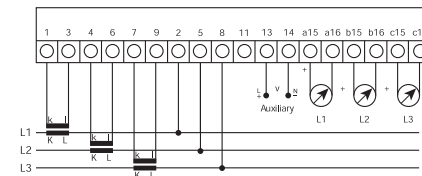

Type 256-XRW/XSW/XJW

3 Ø 4W Unbalanced Load, 3 Elements, Watt, VAR and VA: Watt, VAR and Power Factor. 3 Outputs - Diagram 32

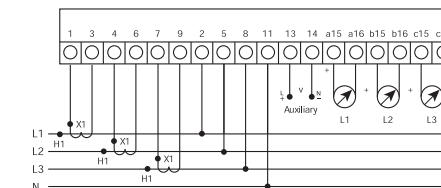
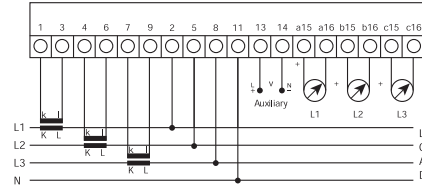

Type 256-TWE/TXG

3 Phase 3-wire Balanced Load, Watt, VAR or Phase Angle - Diagram 34

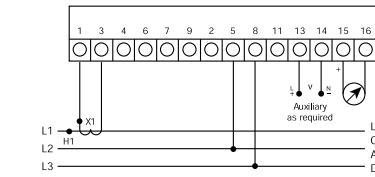
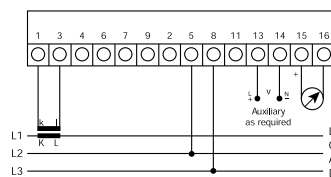

Type 256-TWN/txp/tyN

3 Ø 4W Unbalanced Load, Watt or VAR, or VA - Diagram 35

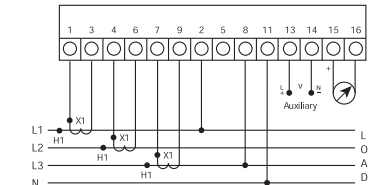
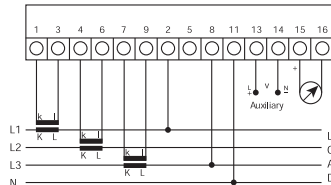

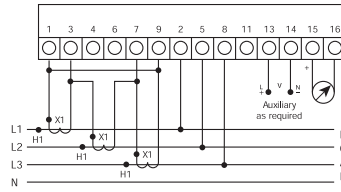
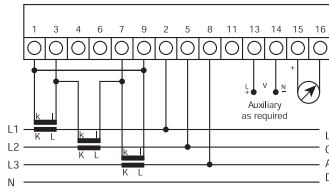

Type 256-TXJ

3 Ø 4W Unbalanced Load, VAr's, Delta Connected CT's – Diagram 37

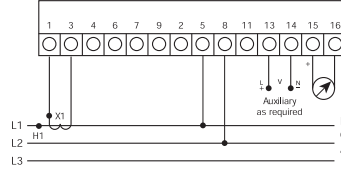
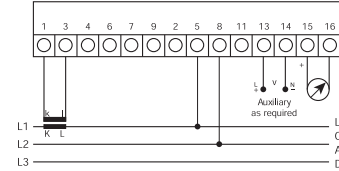

Type 256-TWS

3 Ø 3W Balanced Load, Watts – Diagram 38

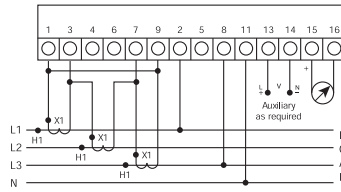
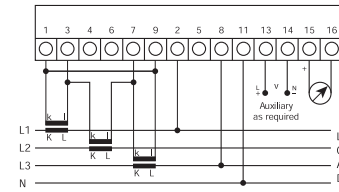

Type 256-TWJ/TYJ

3 Ø 4W Unbalanced Load, Watts or VA Delta Connected CT's – Diagram 39

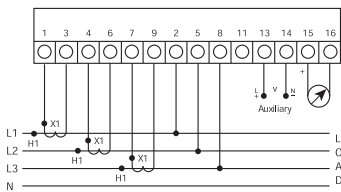
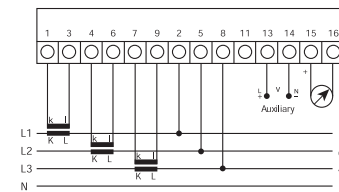

Type 256-TXN

3 Ø 4W, Unbalanced Load, VAr's – Diagram 40

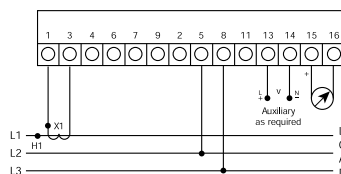
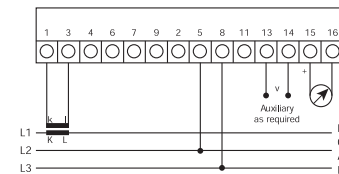

Type 256-TYG, XWL

3 Ø 3W Balanced Load, VA, WATT – Diagram 41

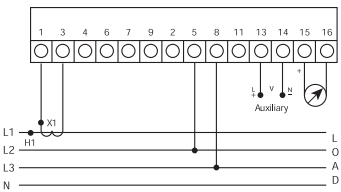
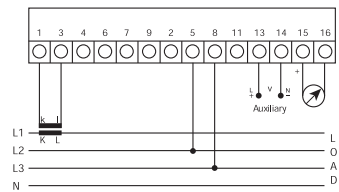

Type 256-TXH/TYH

3 Phase 3/4W, Balanced Load, Phase Angle or Power Factor – Diagram 42

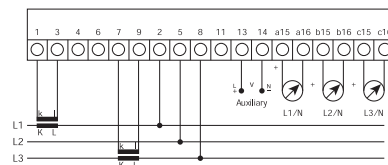

Type 256-XVW/XVY/XVX

3 Ø 3W Voltage, 3 Outputs – Diagram 48

Notes on connection diagrams

1. When using more than one item via a current transformer, inputs must be in series.
2. Auxiliary supply applies only if ordered. For maximum performance an AC or DC auxiliary is recommended. Self powering is achievable for a voltage variation of less than 20%.
3. When there is more than one output the outputs are in the sequence listed on the description, i.e. on a Watt, VAr and VA Transducer, output (a) is Watt, (b) is VAr and (c) is VA.
4. Where more than one output is provided there is no isolation between outputs. User may require a signal isolator (Module 250-ISA).

About TE Connectivity

TE Connectivity is a global, \$14 billion company that designs and manufactures over 500,000 products that connect and protect the flow of power and data inside the products that touch every aspect of our lives. Our nearly 100,000 employees partner with customers in virtually every industry – from consumer electronics, energy and healthcare, to automotive, aerospace and communication networks – enabling smarter, faster, better technologies to connect products to possibilities.

While TE Connectivity (TE) has made every reasonable effort to ensure the accuracy of the information in this catalogue, TE does not guarantee that it is error-free, nor does TE make any other representation, warranty or guarantee that the information is accurate, correct, reliable or current. TE reserves the right to make any adjustments to the information contained herein at any time without notice. TE expressly disclaims all implied warranties regarding the information contained herein, including, but not limited to, any implied warranties of merchantability or fitness for a particular purpose. The dimensions in this catalogue are for reference purposes only and are subject to change without notice. Specifications are subject to change without notice. Consult TE for the latest dimensions and design specifications. TE Connectivity and TE connectivity (logo) are trademarks. CROMPTON is a trademarks of Crompton Parkinson Limited and is used under licence. Other products or company names mentioned herein may be trademarks of their respective owners.

TE Energy – innovative and economical solutions for the electrical power industry: cable accessories, connectors & fittings, insulators & insulation, surge arresters, switching equipment, street lighting, power measurement and control.

Tyco Electronics UK Ltd
TE Energy
Freebournes Road
Witham, Essex CM8 3AH

Registered office:
Faraday Road, Dorcan
Swindon, SN3 5HH
Reg. no. 550 926

Phone: +44 (0)870 870 7500
Fax: +44 (0)870 240 5287
Email: crompton.info@te.com

crompton-instruments.com
energy.te.com

